

LEISTER

PLASTIC WELDING

Zavarivanje plastike

Ekstruderi 2014/15

Jedini izbor za profesionalce

Verzija 4.0



Moguće kombinacije vara

a = veličina vara s = debljina materijala α = ugao zavarivanja

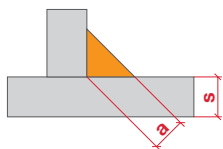

Zobljeni var



Ugaoni spoljašnjii var

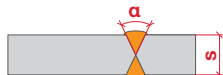

X-var
s = 10 – 40 mm = α 60°
s = 50 – 60 mm = α 50°

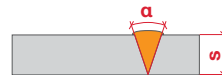



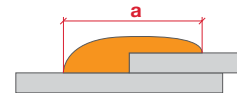

V-var
s = 5 – 20 mm = α 60°
s = 25 – 30 mm = α 50°



Preklonpi var

Uporedni prikaz proizvoda

	Ekstruderi sa elektronikom				Kompaktni ekstruderi
					
Tip uređaja	WELDPLAST S6	WELDPLAST S4	WELDPLAST S2	WELDPLAST S1	WELDMAX
Izlaz (HDPE) kg/h	3.9 – 6	1.5 – 4	0.6 – 2.3	0.2 – 0.8	0.3 – 0.8
Materijal	HD-PE, PP	HD-PE, PP	HD-PE, PP, PVC	PE, PP, PVC, etc.	HD-PE, PP, PVDF
Debljina zida mm	15 – 40	8 – 35	4 – 20	4 – 10	4 – 10
Elektroda Ø mm	4 – 5	3 – 4 / 4 – 5	3 – 4	3 – 4	4
Masa kg	14	8.7	5.8	4.7	3.8
Dužina mm	821	560	450	435	433
Napon V~	230	230	230	230 / 120	230 / 120
Ekstr. sa puž. prenosom	da	da	da	da	ne
Izrada kontejnera	✓✓	✓✓	✓✓	✓✓	✓✓
Izrada cevovoda	✓✓	✓✓	✓✓	✓✓	✓✓
Deponije / građevina	✓✓	✓✓	✓	○	○
Duvalica bez četkica	da	da	da	da	ne
Napomene	1	1	1	1	1

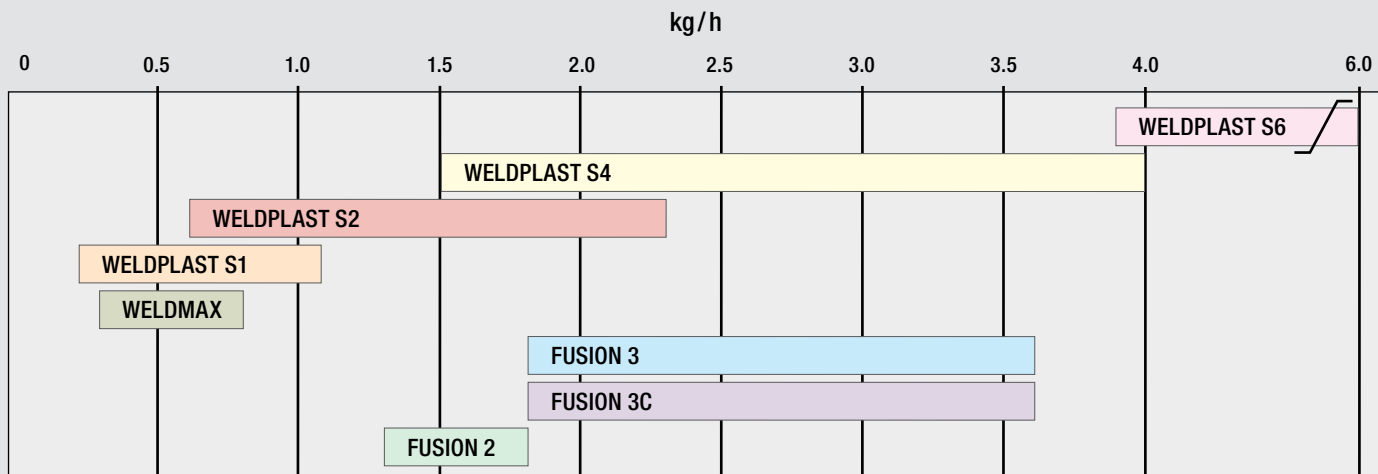

Pregled izlazne mase ručnih ekstrudera





WELDPLAST S2 savršeno zavaruje i u najneznodnijim položajima.







Alati sa toplim vazduhom za zavarivanje plastike

	Ekstruderi		
			
Model	FUSION 3	FUSION 3C	FUSION 2
Izlaz (HDPE) kg/h	1.8 – 3.6	1.8 – 3.6	1.3 – 1.8
Materijal	HD-PE, PP	HD-PE, PP	HD-PE, PP
Debljina zida mm	8 – 25	8 – 25	6 – 15
Elektroda mm	3 – 4 / 4 – 5	3 – 4 / 4 – 5	4
Masa kg	7.2	6.9	5.9
Dužina mm	690	588	450
Napon V~	230	230	230
Ekstr. sa puž. prenosom	da	da	da
Izrada kontejnera	✓✓	✓✓	✓✓
Izrada cevovoda	✓✓	✓✓	✓✓
Deponije / građevina	✓✓	✓	○
Duvalica bez četkica	ne	ne	ne
Napomene	2	2	2

- ✓✓ vrlo pogodan
- ✓ pogodan
- nije pogodan

Napomene:

- 1: Temperature vazduha i plastike se prikazuju na displeju i mogu se posebno podešavati.
- 2: Temperatura vazduha se podešava upotrebom rotacionog potencijometra. Zagrevanje plastike se vrši upotrebom predgrijanog vazduha

	TRIAC ST	12
	Prateća oprema	14 / 15
	TRIAC AT	13
	Prateća oprema	14 / 15
	WELDING PEN R / WELDING PEN S	24
	Prateća oprema	24
	Blower ROBUST	25
	Prateća oprema	25
	DIODE PID / DIODE S	26
	Prateća oprema	27
	Blower MINOR	27
	LABOR S	28
	Prateća oprema	28

WELDPLAST S1: Izuzetno kompaktnan.

Sa novim WELDPLAST S1 kompaktnim ekstruderom, dobijate savršen kvalitet vara sa debljinama ploča od 4 do 12mm i maksimalnu izlaznu snagu od 0.8 kg/h (PVC: do 1.15 kg/h). Dvostruki ulaz za žicu, koji ne uvija žicu, može da radi sa žicama od 3 do 4 mm. Ugrađeno LED osvetljenje plus inovativni radni panel pružaju idealnu kombinaciju za praćenje zavarivanja svih tipičnih materijala (kao što su PE, PP, PVC, PA, PVDF ili ECTFE) – u svakom trenutku. Ergonomski dizajn koji nudi nekoliko mogućnosti hvatanja i držanja, omogućava udoban rad i u nepristupačnim prostorima.

Ekstruder sa elektronikom

WELDPLAST S1

1		Potpuna kontrola: Multifunkcionalna upravljačka jedinica pruža kontrolu nad parametrima zavarivanja, osigurava ponovljive rezultate, i garantuje efikasniji rad.
2		Pametne funkcije: Zahvaljujući ugrađenom otvoru za vešanje, WELDPLAST S1 može da se okači o baalner tako da uvek – bude pri ruci, sprečavajući zamor na poslu.
3		Svestran: WELDPLAST S1 radi sa tipičnim tipovima plastike, kao što su HD-PE, LD-PE, PP, PVC-U, PVC-C, ECTFE, PVDF ili PA.
4		Svetla tačka: Ugrađena LED radna svetla pružaju savršen pogled na proces rada.
5		Više opcija: Dvostrani ulaz za žicu koji ne uvreće žicu za žice od 3 do 4 mm.
6		Fleksibilan: Ova varilica može vrlo lako da izmeni izlaz plastike u procesu zavarivanja. Leister BL dozvoljava beskonačno podešavanje zapremine vazduha.
7		Ergonomsko rukovanje: Kompaktana, ergonomski dizajn, omogućava komforan rad u bilo kom položaju.





Puna kontrola, čak i u skućenom prostoru s avrlo malo svetlosti.

Ekstruder sa elektronikom

WELDPLAST S1



- Funkcionalan, ergonomski dizajn sa dosta mesta za hvatanje
- Izuzetno velika izlazna snaga oD 0.8 kg/čas (HD-PE)
- Ugrađeno LED osvetljenje i deo za kačenje
- Može da radi sa svim tipovima plastike
- Multifunkcionalan panel sa predefinisanim parametrima zavarivanja
- BL duvalica, podesiva zapremina vazduha

Tehnički podaci

Napon	V~	230 / 120 / 100
Snaga	W	1600 / 1800 / 1500
Materijal		HD-PE, LD-PE, PP, PVC-U PVC-C, PVDF, ECTFE, PA
Elektroda	mm	Ø 3 – 4
Izlaz	kg/h	0.2 – 0.8 (PVC do 1.15 kg/h)
Veličina (D × Š × V)	mm	435 × 91 × 264
Ugrađeni profili zavarivanja		HD-PE, PP, PVC-U, PVC-C, PVDF 10 slobodnih mesta za profil
Masa	kg	4.7
Oznaka o usaglašenosti		CE
Šema sertifikovanja		CCA
Zaštita klase I		⊕

Broj artikla:







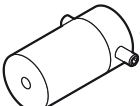

148.396 WELDPLAST S1, 230 V / 1600 W, Ø 3 – 4 mm, Euro priključak

148.395 WELDPLAST S1, 120 V / 1800 W, Ø 3 – 4 mm, Euro priključak

148.394 WELDPLAST S1, 100 V / 1500 W, Ø 3 – 4 mm, Euro priključak

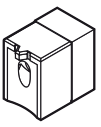
Uračunato u narudžbinu: WELDPLAST S1, korisničko uputstvo, 2 dizne za predgrevanje, cipela-dizna za zavarivanje K10, kutija za odlaganje

Prateća oprema za WELDPLAST S1

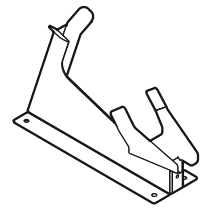
	149.430 Komplet cipela-dizna za zavarivanje Obična
	149.402 Zaobljeni var 5/6
	148.267 Zaobljeni var 8/10
	149.401 Zaobljeni var 12
	149.388 V-var 3 / 4
	149.383 V-var 5 / 6
	149.385 V-var 8 / 10
	149.364 Ugaoni
	148.923 Nosač alata



Zavarivanje plastike

WELDPLAST S6: Udarnik.

WELDPLAST S6 je najcenjeniji svetski ručni ekstruder. Sa izlazom od 6 kg/h, izuzetno je lagan za rukovanje. Posедуje predgrejani motor bez četkica, multifunkcionalan displej i udobnu ergonomsku ručku, što S6 čini vrhom ponude.



WELDPLAST S6 je lak za kontrolu zahvaljujući kružnoj dršci.

Ekstruder sa elektronikom

WELDPLAST S6



- 6 kg output per hour
- Highest possible preheating capacity
- Adjustable control wheel
- Maintenance-free hot-air blower
- Multifunctional display







Tehnički podaci

Napon	V~	230
Snaga	W	4600
Materijal		PE / PP
Elektroda	mm	Ø 4 or Ø 5
Izlaz	kg/h	3.9 – 6.0
Veličina (D × Š × V)	mm	821 × 116 × 240
Masa	kg	14
Oznaka o usaglašenosti		CE
Oznaka o odobrenosti		Ⓢ
Zaštita klase I		Ⓛ

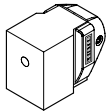
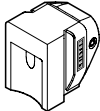
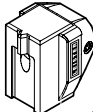
Broj artikla:

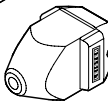
134.318 WELDPLAST S6, 230 V / 5300 W, CEE 32A plug
 Uračunato u narudžbinu: WELDPLAST S6, overlap cipela-dizna za zavarivanje, kutija za odlaganje

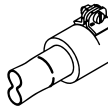
Prateća oprema WELDPLAST S6

		Komplet cipela-dizna za zavarivanje	
	146.239	54 × 40 × 52 mm	obična cipela-dizna
	146.240	74 × 50 × 58 mm	obična cipela-dizna
	146.241	25 mm	preklopni
	146.242	35 mm	preklopni
	145.899	40 mm	preklopni
	146.245	20 mm	V-var
	146.246	25 mm	V-var
	146.247	30 mm	V-var
	146.232	20 mm	zaobljeni var (a = 14 mm*)
	146.233	25 mm	zaobljeni var (a = 17,5 mm*)
	146.234	30 mm	zaobljeni var (a = 21 mm*)
	146.644	Ugaoni spoljašnjii var	10 mm
	146.646	Ugaoni spoljašnjii var	12 mm
	146.652	Ugaoni spoljašnjii var	15 mm
	146.230	Ugaoni var	Ø 14 mm
	146.218	Ugaoni var	Ø 20 mm
	144.905	45°	ugaoni adapter
	145.705	90°	ugaoni adapter
		Upozorenje: mora se koristiti cipela-dizna za zavarivanje sa ugrađenom vodičom za vazduh.	
	117.055	35 mm	dizna za predgrevanje, velika
	136.859	50 mm	dizna za predgrevanje, XL Velika
	117.790		Bočna vodiča za topao vazduh

*a = Debljina vara

WELDPLAST S4: Kolega.

WELDPLAST S4 je prvi ekstruder ove vrste sa motorom bez četkica koji ne zahteva održavanje za proizvodnju predgrejanog vazduha. Izlaz do 4 kilograma na sat je moguć zahvaljujući snažnom pogonu koji poseduje S4.



The powerful WELDPLAST S4 in use.

Ekstruder sa elektronikom

WELDPLAST S4



- Kompaktno kućište smanjuje buku i garantuje optimalno hlađenje elektronike i pogona
- Mikroprocesor kontroliše proces zavarivanja i prati opterećenje
- Meni sa funkcijama
- Dvostrani ulaz za kabl
- Duvalica kojoj ne treba održavanje

Tehnički podaci











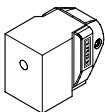
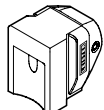
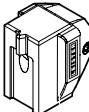
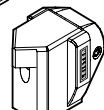
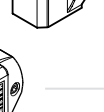

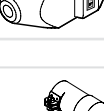
Napon	V~	230
Snaga	W	3680
Materijal		PE / PP
Elektroda	mm	Ø 3 – 4 Ø 4 – 5
Izlaz	kg/h	1.5 – 4.0
Veličina (D × Š × V)	mm	560 × 110 × 300
Masa	kg	8.7
Oznaka o usaglašenosti		CE
Oznaka o odobrenosti		ES
Šema sertifikovanja		CCA
Zaštita klase I		⊕

Broj artikla:

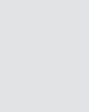
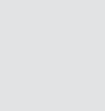
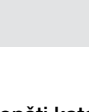
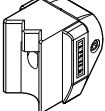
- 116.948 WELDPLAST S4, 230 V / 3680 W, 3 – 4 mm, sa Euro priključkom, obična cipela-dizna za zavarivanje
- 146.813 WELDPLAST S4, 230 V / 3680 W, 4 – 5 mm, sa Euro priključkom, cipela-dizna za zavarivanje K 15

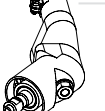
Uračunato u narudžbinu: WELDPLAST S4, dizna za predgrevanje velika, srednja i mala, kutija za odlaganje

Prateća oprema WELDPLAST S4

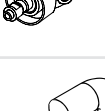
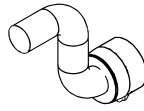
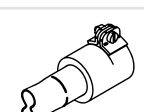
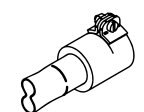
		Komplet cipela-dizna za zavarivanje	
	146.239	54 × 40 × 52 mm obična cipela-dizna	
	146.240	74 × 50 × 58 mm obična cipela-dizna	
	146.241	25 mm preklopni	
	146.242	35 mm preklopni	
	145.899	40 mm preklopni	
	146.243	12 mm V-var	
	146.244	15 mm V-var	
	146.245	20 mm V-var	
	146.246	25 mm V-var	
	146.247	30 mm V-var	
	146.231	15 mm zaobljeni var (a = 10 mm*)	
	146.232	20 mm zaobljeni var (a = 14 mm*)	
	146.233	25 mm zaobljeni var (a = 17.5 mm*)	
	146.234	30 mm zaobljeni var (a = 21 mm*)	
	146.642	Ugaoni spoljašnjii var 8 mm	
	146.644	Ugaoni spoljašnjii var 10 mm	
	146.646	Ugaoni spoljašnjii var 12 mm	
	146.652	Ugaoni spoljašnjii var 15 mm	
	146.230	Ugaoni var Ø 14 mm	
	146.218	Ugaoni var Ø 20 mm	
	144.904	Ugaoni adapter 45°	
	145.704	Ugaoni adapter 90°	
		Upozorenje: mora se koristiti cipela-dizna za zavarivanje sa ugrađenom vodicom za vazduh.	
	117.064	Bočna vodica za topao vazduh	
	117.065	Gornja vodica za topao vazduh	
		Dizna za predgrevanje	
	117.053	20 mm, small	
	117.518	25 mm, medium	
	141.177	35 mm, large	

* a = Debljina vara

WELDPLAST S2 / S2 PVC: Remek-dela.

WELDPLAST S2 i S2 PVC su remek-dela moderne tehnologije. Ispunjavaju najstrožije zahteve u pogledu funkcionalnosti eksterijera i dizajna, dok njegova unutrašnjost ispunjava zahteve u pogledu obrade materijala.

WELSDPLAST S2 PVC je specijalno projektovan da zadovolji zahteve PVC ekstruzionog zavarivanja. Savršeni kvalitet vara i ugrađena zaštita protiv korozije čine ih savršenim partnerima.

Ekstruder sa elektronikom

WELDPLAST S2



- Duvalica koja se ne održava
- Savršeni kvalitet vara
- Multifunkcionalni displej
- Ergonomičan oblik
- Uspešno se koristi širom svet

Tehnički podaci		
Napon	V~	230
Snaga	W	3000
Materijal		PE / PP Drugi materijali na zahtev
Elektroda	mm	Ø 3 or Ø 4
Izlaz Ø 3 mm	kg/h	PE: 0.6 – 1.3 PP: 0.5 – 1.2
Izlaz Ø 4 mm	kg/h	PE: 1.0 – 2.3 PP: 0.9 – 2.0
Veličina (D × Š × V)	mm	450 × 98 × 260
Masa	kg	5.8
Oznaka o usaglašenosti		CE
Oznaka o odobrenosti		§
Šema sertifikovanja		CCA
Zaštita klase I		⊕

Broj artikla:

127.215 WELDPLAST S2, 230 V / 3000 W, Euro priključak

Uračunato u narudžbinu: WELDPLAST S2, cipela-dizna za zavarivanje u delovima, kutija za odlaganje

Ekstruder sa elektronikom

WELDPLAST S2 PVC



- Optimizovan za PVC-U
- Savršen kvalitet vara
- PVC specifični ekstruzioni meni
- Zaštita od korozije
- Standby režim

Tehnički podaci		
Napon	V~	230
Snaga	W	3000
Materijal		PVC-U, PE, PP Drugi materijali na zahtev
Elektroda	mm	Ø 3 or Ø 4
Izlaz Ø 3 mm	kg/h	PVC-U: 0.9 – 1.7 PE: 0.6 – 1.3
Izlaz Ø 4 mm	kg/h	PVC-U: 1.5 – 2.7 PE: 1.0 – 2.3
Veličina (D × Š × V)	mm	450 × 98 × 260
Masa	kg	5.8
Oznaka o usaglašenosti		CE
Oznaka o odobrenosti		§
Šema sertifikovanja		CCA
Zaštita klase I		⊕

Broj artikla:

135.724 WELDPLAST S2 PVC, 230 V / 3000 W, Euro priključak

Uračunato u narudžbinu: WELDPLAST S2 PVC, 3 dizne za predgrevanje, cipela-dizna za zavarivanje K 8 / 10 mm (Br. art. 146.236), kutija za odlaganje



WELDPLAST S2 u akciji.



Lako se zavaruju i unutrašnji radijusi.

Prateća oprema WELDPLAST S2

	145.945	Komplet cipela-dizna za zavarivanje 45 × 30 × 54 mm obična cipela-dizna za zavarivanje
	145.946	
	145.896	74 × 50 × 58 mm obična cipela-dizna za zavarivanje
	145.947	
	145.897	25 mm preklopni
		30 mm preklopni
		35 mm preklopni
	145.912	5 / 6 V-var
	145.915	
	145.907	8 / 10 V-var
	145.903	12 mm V-var
	145.909	15 mm V-var
	145.916	20 mm V-var
		25 mm V-var
	145.943	5 / 6 mm zaobljeni var (a = 4.2 mm*)
	145.944	
	145.812	8 / 10 mm zaobljeni var (a = 7 mm*)
	145.940	15 mm zaobljeni var (a = 10*)
	145.816	20 mm zaobljeni var (a = 14 mm*)
		25 mm zaobljeni var (a = 17.5 mm*)
	146.643	Ugaoni spoljašnjii var 8 mm
	146.645	
	146.649	Ugaoni spoljašnjii var 10 mm
	146.651	Ugaoni spoljašnjii var 12 mm
		Ugaoni spoljašnjii var 15 mm
	145.811	Ugaoni var Ø 14 mm
	145.488	
		Ugaoni var Ø 20 mm
	139.460	45° ugaoni adapter
	139.461	90° ugaoni adapter

* a = Debljina vara

Prateća oprema WELDPLAST S2 PVC

	146.239	Komplet cipela-dizna za zavarivanje 54 × 40 × 52 mm obična cipela-dizna
	146.240	
	146.241	74 × 50 × 58 mm obična cipela-dizna
	146.242	
		25 mm preklopni
		35 mm preklopni
	146.248	5 / 6 mm V-var
	146.249	8 / 10 mm V-var
	146.243	12 mm V-var
	146.244	15 mm V-var
	146.235	5/6 mm zaobljeni var (a = 4.2 mm*)
	146.236	8/10 mm zaobljeni var (a = 7 mm*)
	146.231	15 mm zaobljeni var (a = 10 mm*)
	146.642	Ugaoni spoljašnjii var 8 mm
	146.644	Ugaoni spoljašnjii var 10 mm
	146.646	Ugaoni spoljašnjii var 12 mm
	146.652	Ugaoni spoljašnjii var 15 mm
	146.230	Ugaoni var Ø 14 mm
	146.218	Ugaoni var Ø 20 mm
	133.850	Gornja vodica za topao vazduh

* a = Debljina vara



Upotrba WELDPLAST S2 daje savršeni var



45° ugaoni adapter za WELDPLAST S2 olakšava zavarivanje u teškim pozicijama (prateća oprema)

FUSION 3: Dugačak i vitak.

Svojim dugim i uskim oblikom, FUSION 3 omogućava udoban rad i lako korišćenje, čak i na podu.

Ekstruder

FUSION 3



- Odlične performanse zavarivanja
- Kompaktan
- Zaštita od hladnog starta
- Jednostavan za upotrebu
- Dvostarni ulaz kabla sa zaštitom od uvijanja
- 360° rotaciona cipela-dizna

Tehnički podaci

	mm	Verzija Ø 3 – 4		Verzija Ø 4 – 5	
		3	4	4	5
Elektroda Ø	mm				
Izlaz PE	kg/h	2.0 – 2.5	2.7 – 3.6	2.1 – 2.6	2.7 – 3.6
Izlaz PP	kg/h	1.8 – 2.3	2.5 – 3.4	1.8 – 2.4	2.5 – 3.4
Napon	V~	230			
Snaga	W	3500			
Materijal		PE / PP			
Veličina (D × Š × V)	mm	670 × 90 × 180			
Masa	kg	7.2			
Oznaka o usaglašenosti		CE			
Oznaka o odobrenosti		E			
Šema sertifikovanja		CCA			
Zaštita klase II		II			

Broj artikla:

118.300 FUSION 3, 230 V / 3500 W, elektroda Ø 3 – 4 mm, Euro priključak
144.615 FUSION 3, 230 V / 3500 W, elektroda Ø 4 – 5 mm, Euro priključak

Uračunato u narudžbinu: FUSION 3, obična cipela-dizna za zavarivanje, kutija za odlaganje

FUSION 3C: Kratak i pogodan.

The somewhat shorter FUSION 3C provides an astounding output volume of up to 3.6 kilograms per hour.

Ekstruder

FUSION 3C



- Odlične performanse zavarivanja
- Kompaktan
- Zaštita od hladnog starta
- Jednostavan za upotrebu
- Dvostarni ulaz kabla sa zaštitom od uvijanja
- 360° rotaciona cipela-dizna za zavarivanje

Tehnički podaci

	mm	Verzija Ø 3 – 4		Verzija Ø 4 – 5	
		3	4	4	5
Elektroda Ø	mm				
Izlaz PE	kg/h	2.0 – 2.5	2.7 – 3.6	2.1 – 2.6	2.7 – 3.6
Izlaz PP	kg/h	1.8 – 2.3	2.5 – 3.4	1.8 – 2.4	2.5 – 3.4
Napon	V~	230			
Snaga	W	2800			
Materijal		PE / PP			
Veličina (D × Š × V)	mm	588 × 98 × 225			
Masa	kg	6.9			
Oznaka o usaglašenosti		CE			
Oznaka o odobrenosti		E			
Šema sertifikovanja		CCA			
Zaštita klase II		II			

Broj artikla:

123.866 FUSION 3C, 230 V / 2800 W, elektroda Ø 3 – 4 mm, Euro priključak
144.826 FUSION 3C, 230 V / 2800 W, elektroda Ø 4 – 5 mm, Euro priključak

Uračunato u narudžbinu: FUSION 3C, obična cipela-dizna za zavarivanje, kutija za odlaganje







Savr.

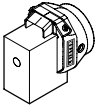
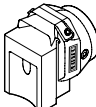
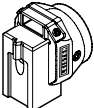

FUSION 3C priilikom pravljenja V-vara.

Prateća oprema FUSION 3 / 3C

Komplet cipela-dizna za zavarivanje	
	145.945 50 × 30 × 38 mm obična cipela-dizna
	145.946 74 × 50 × 58 mm obična cipela-dizna
	145.896 25 mm preklopni
	145.947 30 mm preklopni
	145.897 35 mm preklopni
	145.912 5 / 6 V-var
	145.915 8 / 10 mm V-var
	145.907 12 mm V-var
	145.903 15 mm V-var
	145.909 20 mm V-var
	145.916 25 mm V-var
	145.943 5 / 6 mm zaobljeni var (a = 4.2 mm*)
	145.944 8 / 10 mm zaobljeni var (a = 7 mm*)
	145.812 15 mm zaobljeni var (a = 10 mm*)
	145.940 20 mm zaobljeni var (a = 14 mm*)
	145.816 25 mm zaobljeni var (a = 17.5 mm*)
	146.643 Ugaoni spoljašnjii var 8 mm
	146.645 Ugaoni spoljašnjii var 10 mm
	146.649 Ugaoni spoljašnjii var 12 mm
	146.651 Ugaoni spoljašnjii var 15 mm
	145.811 Ugaoni var Ø 14 mm
	145.488 Ugaoni var Ø 20 mm

* a = Debljina vara

FUSION 2: Mali snagaš.

The FUSION 2 convinces with its ergonomic design. The simple operation and first-class welding quality have helped it to become the breakthrough product.



FUSION 2 prilikom upotrebe u Kini.

Ekstruder

FUSION 2



- Sa samo 450 mm, i najmanji je u klasi!
- Zaštita motora sprečava hladan start
- Jednostavan za rukovanje
- Dvostrani ulaz kabla
- 360° rotaciona cipela-dizna
- Integrisana elektronika za kontinualno podešavanje temperature

Tehnički podaci

Napon	V~	230
Snaga	W	2800
Materijal		PE / PP
Temp. vazduha	°C	up to 340
Temperatura plastificiranja	°C	up to 300
Elektroda	Ø mm	4
Izlaz PE	kg/h	1.3 – 1.8
Veličina (D × Š × V)	mm	450 × 98 × 225
Masa	kg	5.9 (without cable)
Oznaka o usaglašenosti		CE
Oznaka o odobrenosti		(\$)
Šema sertifikovanja		CCA
Zaštita klase II		□

Broj artikla:

119.200 FUSION 2, 230 V / 2800 W, Euro priključak

Uračunato u narudžbinu: FUSION 2, obična cipela-dizna za zavarivanje, kutija za odlaganje

Prateća oprema za FUSION 2

Komplet cipela-dizna za zavarivanje	
145.945	45 × 30 × 54 mm obična cipela-dizna
145.946	74 × 50 × 58 mm obična cipela-dizna za zavarivanje
145.896	25 mm preklopni
145.947	30 mm preklopni
145.897	35 mm preklopni
145.912	5 / 6 V-var
145.915	8 / 10 mm V-var
145.907	12 mm V-var
145.903	15 mm V-var
145.943	5 / 6 mm zaobljeni var (a = 4.2 mm*)
145.944	8 / 10 mm zaobljeni var (a = 7 mm*)
145.812	15 mm zaobljeni var (a = 10 mm*)
146.643	Ugaoni spoljašnjii var 8 mm
146.645	Ugaoni spoljašnjii var 10 mm
146.649	Ugaoni spoljašnjii var 12 mm
146.651	Ugaoni spoljašnjii var 15 mm
145.811	Ugaoni var Ø 14 mm
145.488	Ugaoni var Ø 20 mm

* a = Debljina vara

WELDMAX: Mali ali lep.

Najmanji alat sa puno snage: Sa posebno regulisanim sistemima za predgrejani vazduh i punjenje, lagani i kompaktni WELDMAX ispunjava i najstrožije zahteve.



Lagani i tihi WELDMAX.

Kompaktni ekstruder

WELDMAX



- Kompaktan i tih zahvaljujući transportnom sistemu bez puža
- Najlakši Leister ručni ekstruder
- Idealan za zatvorene prostore
- Odvojena, kontinualna kontrola temperature za plastifikaciju i predgrevani vazduh

Tehnički podaci

Napon	V~	230
Snaga	W	2200
Materijal		PE / PP / PVDF / PA (drugi materijali dostupni na zahtev)
Elektroda	mm	Ø 4 ± 0.3
Izlaz (HDPE Ø 4)	kg/h	0.3 – 0.8
Veličina (D × Š × V)	mm	443 × 94 × 255, handle Ø 57
Masa	kg	3.8
Oznaka o usaglašenosti		CE
Oznaka o odobrenosti		Ⓢ
Šema sertifikovanja		CCA
Zaštita klase II		□

Broj artikla:

110.272 WELDMAX, 230 V / 2200 W, with EU-plug, kutija za odlaganje

Dodatne verzije dostupne na zahtev

Prateća oprema WELDMAX

Komplet cipela-dizna za zavarivanje	
112.830	Obična cipela-dizna za zavarivanje
112.629	5 mm V-var
112.621	6 mm V-var
112.623	8 mm V-var
112.624	10 mm V-var
112.630	5 mm zaobljeni var (a = 3.5 mm*)
112.625	6 mm zaobljeni var (a = 4.2 mm*)
112.627	8 mm zaobljeni var (a = 5.6 mm*)
112.628	10 mm zaobljeni var (a = 7 mm*)
112.626	20 mm preklopni

* a = Debljina vara



Zavarivanje PE kontejnera upotrebom DIODE PID.



WELDPLAST S4 na gradilištu u Španiji..

Opšta prateća oprema za ekstrudere

	<p>Nosač alata 131.451 WELDPLAST S2 / S2 PVC / FUSION 2</p>
	<p>118.804 WELDPLAST S4 / FUSION 3 / FUSION 3C</p>
	<p>Reflektor dizna za predgrevanje 136.231 WELDPLAST S2 / S2 PVC / S4 / S6 FUSION 2 / 3 / 3C</p>
	<p>Grejni element 134.567 230 V / 2600 W, WELDPLAST S6 109.984 230 V / 2200 W, WELDPLAST S4 / S2 / S2 PVC 113.268 230 V / 1100 + 1100 W, FUSION 3 123.561 230 V / 1750 W, FUSION 2 / 3C 112.638 230 V / 1400 W, WELDMAX</p>
	<p>134.361 Filter za vazduh WELDPLAST S2 / S2 PVC (uračunato u narudžbinu) 143.776 Tekstilni filter za prašinu WELDPLAST S2 / S2 PVC (not uračunato u narudžbinu)</p>
	<p>135.082 Filter za vazduh FUSION 2 / 3C</p>
	<p>144.095 Odmotavač elektrode</p>
	<p>Kutija za skladištenje (uračunato u narudžbinu) 116.367 WELDPLAST S6 123.173 WELDPLAST S4 / FUSION 3 119.540 WELDPLAST S2 / S2 PVC / FUSION 2 / 3C / WELDMAX</p>

Opšta prateća oprema

Zavarivanje plastike

	<p>107.348 Nosač alata za TRIAC AT, TRIAC BT, TRIAC S, TRIAC ST, ELECTRON, ELECTRON ST</p>
	<p>137.855 Leister nož sa 4 rezervna sečiva</p>
	<p>138.902 10 x 10 rezervna sečiva u obliku kuke 138.539 10 x 10 rezervna sečiva u obliku trapezoida</p>
	<p>116.586 Kutija za skladištenje for TRIAC AT, TRIAC ST, TRIAC S, ELECTRON ST</p>



Elektrode za zavarivanje

Artikal		pakovanje (kg)
Prateća oprema za PE		
104.283	HDPE elektroda, profil A, crna	3
104.294	HDPE elektroda, profil A, bela	3
104.284	HDPE elektroda, profil B, crna	5
104.299	HDPE elektroda, profil B, bela	5
106.650	HDPE elektroda, 8x 2 mm, bela	1
104.300	LDPE elektroda, profil A, crna	3
Prateća oprema za PP		
104.287	PP elektroda, profil A, siva / bež	3
104.301	PP elektroda, profil A, crna	3
104.288	PP elektroda, profil B, siva / bež	5
126.356	PP elektroda, 8x 2 mm, prirodna	2
Prateća oprema za PVC		
104.296	PVC-U elektroda (tvrda), profil A, transparentna	3
104.278	PVC-U elektroda (tvrda), profil A, siva	3
106.641	PVC-U elektroda, profil A, braon	3
104.280	PVC-U elektroda (tvrda), profil B, braon	5
104.279	PVC-U elektroda (tvrda), profil B, siva	5
104.302	PVC-P elektroda (meko), profil A, transparentna	3
Prateća oprema za ABS		
104.295	ABS elektroda, profil A, bela	3
113.587	ABS elektroda, profil A, crna	3
107.027	ABS traka za zavarivanje, 8x 2 mm, bela	1

Artikal		pakovanje (kg)
Prateća oprema za div.		
104.297	PA elektroda, profil A, crna	3
104.298	PC elektroda, profil A, transparentna	3
104.313	PC elektroda / ABS / ALPHA (Honda), profil A, crna	3
104.311	PC elektroda / PBTP (Xenoy), profil A, siva	3
104.309	PS elektroda, profil A, bela	3
104.308	PUR elektroda, profil A, crna	3
106.654	Xenoy traka za zavarivanje, 8x 2 mm, siva	2
106.642	PPs elektroda, profil A, siva, vatrootporna	3
104.304	PVDF elektroda, profil A, prirodna	3
104.303	POM elektroda, profil A, prirodna	3
Test bundles		
107.036	Komplet elektroda za ispitivanje, koji se sastoji od primera-ka profila A dužine of 37 mm pojedinačno obeleženih 6x HDPE, 6x PP, 6x PA, 6x PC, 6x ABS, 6x PCABS / APLHA Honda, 6x PC / PBTP / Xenoy	
107.037	Standard za testiranje koji se sastoji od komada profila A dužine 37 mm pojedinačno obeleženih 5x PVC-U, 5x PVC-P, 5x PP, 5x ABS, 5x HDPE, 3x PC, 3x PA, 3x POM, 3x LDPE, 3x PC / ABS / ALPHA Honda, 3x PC / PBTP / Xenoy	
107.040	Standard za testiranje koji se sastoji od trake profila A dužine 37 mm pojedinačno obeleženih 9x HDPE, 8x 2 mm bela, 9x PP, 8x 2 mm prirodna, 9xABS, 8x 2 mm bela, 9x PC / PBTP / Xenoy siva	

Profile sizes

	Profile A Dimensions in mm
	Profile B



Mi smo lokalni širom svuda

Leister Technologies AG
Galileo-Strasse 10
CH-6056 Kaegiswil / Switzerland
phone: +41 41 662 74 74
fax: +41 41 662 74 16
leister@leister.com

Leister Technologies LLC
Itasca, IL 60143 / USA
phone: +1 630 760 1000
info@leisterusa.com

Leister Technologies Ltd.
Shanghai 201 109 / PRC
phone: +86 21 6442 2398
leister@leister.cn

Leister Technologis KK
Yokohama 222-0033 / Japan
phone: +81 45 477 36 37
info@leister.co.jp

Leister Technologies Benelux BV
3991 CE Houten / Nederland
phone: +31 (0)30 2199888
info@leister.nl

Leister Technologies India Pvt
600 041 Chennai / India
phone: +91 44 2454 3436
info@lipipolymers.com

Naša međunarodna mreža obuhvata preko 120 centara za prodaju i servisiranje u preko 90 zemalja.

Evropa:

Austrija
Belorusija
Belgija
Bugarska
Hrvatska
Kipar
Češka
Estonija
Danska
Finska
Francuska
Nemačka
Velika Britanija
Grčka
Mađarska
Irska
Island
Italija

Kazahstan
Letonija
Litvanija
Holandija
Norveška
Poljska
Portugal
Rumunija
Rusija
Srbija
Slovačka
Slovenija
Španija
Švedska
Švajcarska
Turska
Ukrajina

Amerika:

Kanada
Meksiko
SAD
Argentina
Brazil
Čile
Kolumbija
Kosta Rika
Ekvador
Venecuela
Peru

Afrika:

Alžir
Egipat
Kenija
Maroko
Južna Afrika
Tunis

Bliski Istok:

U.A.E.
Saudi Arabija
Katar
Iran
Irak

Azija-Pacific:

N.R.Kina
Hong Kong
Indija
Indonezija
Japan
Koreja
Malezija
Mongolija
Filipini
Singapur
Tajvan
Tajland
Vijetnam

Okeanija:

Australija
Novi Zeland

© Copyright by Leister, Switzerland

Ovlašćeni servisni i distributivni centar:

MARCOM-PLAST D.O.O.
11070 Novi Beograd, Srbija
Gandijeva 5
tel. +381 11 41-27-058
mob. +381 60 41-27-058
www.marcom-plast.rs
office@marcom-plast.rs



Švajcarski kvalitet